

REVISIONS					
LTR	ECO	DESCRIPTION	DATE	APPROVED	ZONE
A		INITIAL_RELEASE	1/18/2016	RWW	
B		REV_TITLE_BLOCK_ADD_UNROLL_DIRECTION	3/28/2016	RWW	

NOTES:
XXXXX

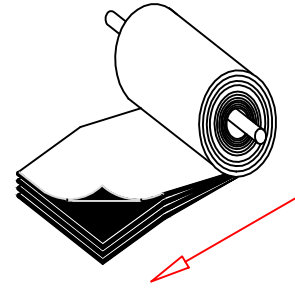

THESE INSTRUCTIONS
ARE FOR UNROLLING FROM
THE BOTTOM OF THE ROLL

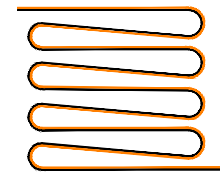

PIECE 1

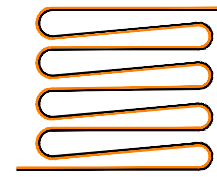
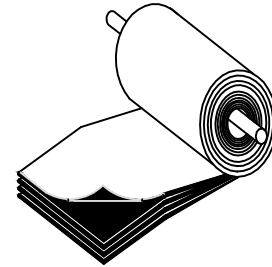

PIECE 2

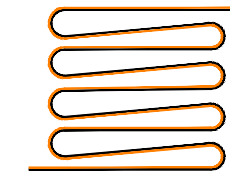
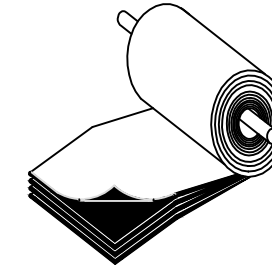

PIECE 3

← UNFOLD

UNFOLD →

UNFOLD →

BUNKER STARTING END

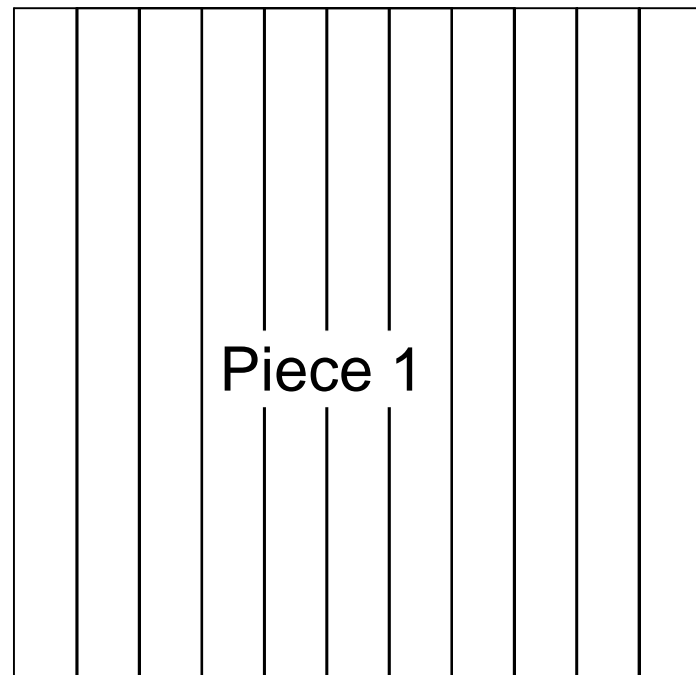

Piece 1

PULL PIECE 1 FROM ROLL ↑

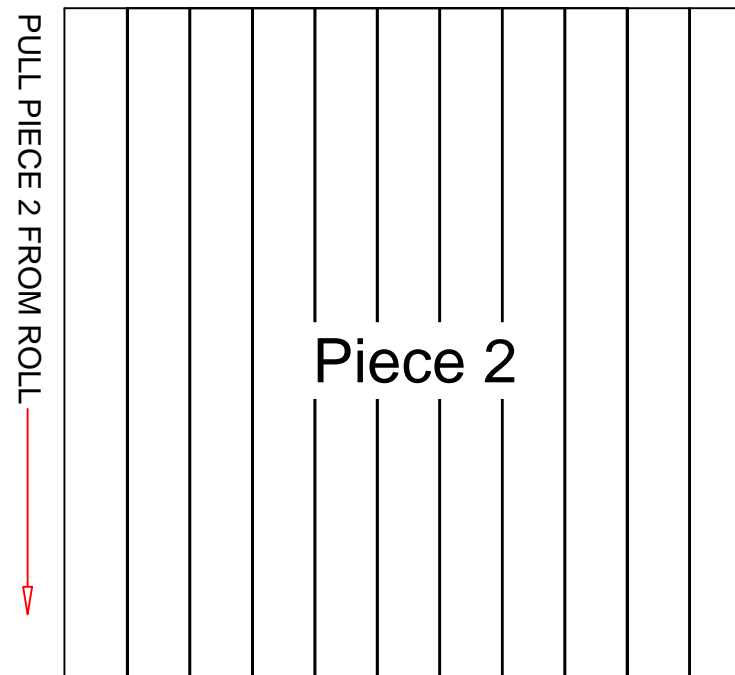

Piece 2

PULL PIECE 2 FROM ROLL ↓



Piece 3

PULL PIECE 3 FROM ROLL ↓

BUNKER FINISHING END

DEPLOYMENT INSTRUCTIONS;

1. PULL PIECE 1 & 2 ACROSS THE GRAIN PILE ABOUT 1/3 OF THE WAY FROM THE STARTING END
2. SEW PANELS AS SHOWN ON THE SEWING INSTRUCTIONS, (PAGE 2 AND 3)
3. WHILE HOLDING PIECE 2, UNFOLD PIECE 1 TO THE STARING END OF THE BUNKER
4. UNFOLD PIECE 2
5. UNROLL PIECE 3
6. SEW PIECE 3 TO PIECE 2 AS SHOWN ON THE SEWING INSTRUCTIONS, (PAGE 2 AND 3)
7. UNFOLD PIECE 3 TO THE FINISHING END OF THE BUNKER
FOR FURTHER INSTRUCTIONS VISIT ravenefd.com/installation

		COVER TYPE			
		OVAL 3 PIECE Accordion Fold No Options Page 1 of 3			
RAVEN ENGINEERED FILMS PO BOX 5107 SIOUX FALLS, SD 57117-5107 +1 (800) 635-3456		SIZE	SALES ORDER	DRAWING NUMBER	REV
DRAWN	RWW	1/18/2016	B	I	O3NOAS B
DO NOT SCALE DRAWING		PROPRIETARY AND CONFIDENTIAL INFORMATION OF RAVEN INDUSTRIES INC. THIS DRAWING AND THE INFORMATION HEREON ARE RAVEN INDUSTRIES INC. PROPERTY AND MAY BE USED BY OTHERS ONLY AS AUTHORIZED IN WRITING BY RAVEN INDUSTRIES INC. - ALL RIGHTS RESERVED UNDER THE COPYRIGHT LAWS.			

8

7

6

5

4

3

2

1

REVISIONS					
LTR	ECO	DESCRIPTION	DATE	APPROVED	ZONE
A		INITIAL_RELEASE	1/18/2016	RWW	
B		REV_TITLE_BLOCK	3/28/2016	RWW	

NOTES:
XXXXX

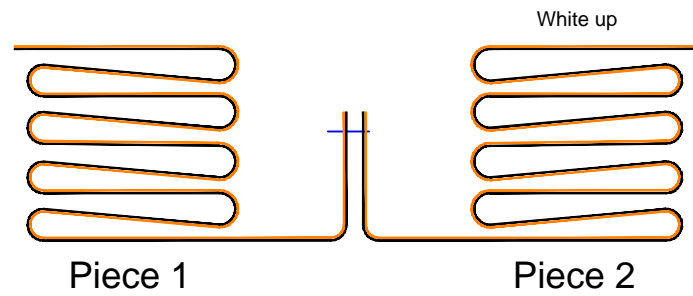

FIGURE 1

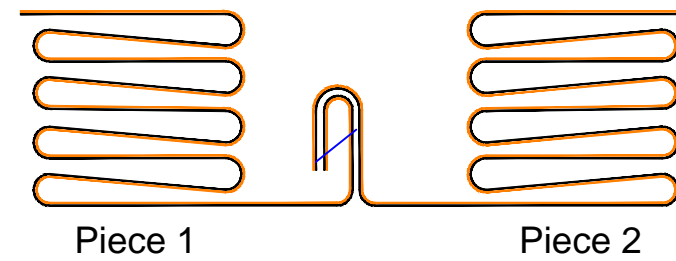

FIGURE 2

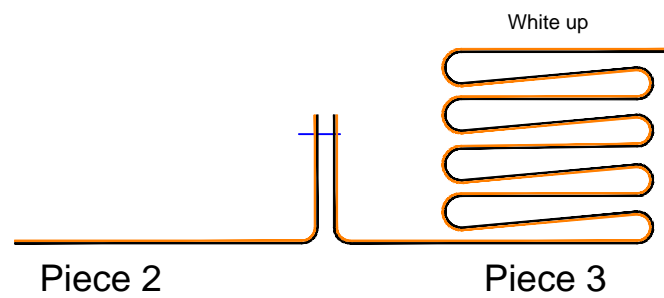

FIGURE 3

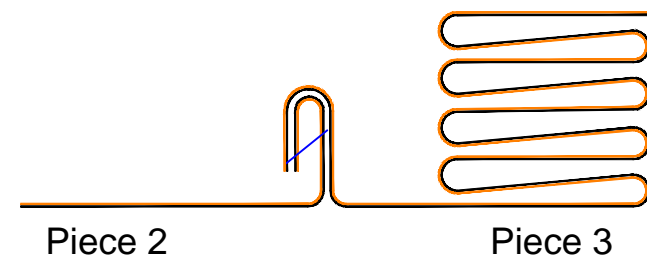

FIGURE 4

SEWING INSTRUCTIONS

1. ONCE FIRST AND SECOND PIECE ARE UNROLLED, BRING THE BOTTOM OF BOTH PIECES TOGETHER BLACK TO BLACK, (FIGURE1)
2. SEW ACROSS THE ENTIRE SEAM AS SHOWN IN THE GENERAL SEWING INSTRUCTIONS, (PAGE 3)
3. FOLD THE SEAM OVER AND SEW THE ENTIRE SEAM AS SHOWN IN THE GENERAL INSTRUCTIONS, (FIGURE 2)
4. ONCE PIECE 3 IS UNROLLED, BRING THE BOTTOM OF BOTH PIECES TOGETHER BLACK TO BLACK, (FIGURE 3)
5. SEW ACROSS THE ENTIRE SEAM AS SHOWN IN THE GENERAL SEWING INSTRUCTIONS, (PAGE 3)
6. FOLD THE SEAM OVER AND SEW THE ENTIRE SEAM AS SHOWN IN THE GENERAL INSTRUCTIONS, (FIGURE 4)
FOR FURTHER INSTRUCTIONS VISIT ravenefd.com/installation

	COVER TYPE		
	OVAL 3 PIECE Accordion Folded No Options		
RAVEN ENGINEERED FILMS PO BOX 5107 SIOUX FALLS, SD 57117-5107 +1 (800) 635-3456			SALES ORDER
DRAWN		DATE	DRAWING NUMBER
RWW		1/18/2016	O3NOAS
DO NOT SCALE DRAWING			REV B
PROPRIETARY AND CONFIDENTIAL INFORMATION OF RAVEN INDUSTRIES INC. THIS DRAWING AND THE INFORMATION HEREON ARE RAVEN INDUSTRIES INC. PROPERTY AND MAY BE USED BY OTHERS ONLY AS AUTHORIZED IN WRITING BY RAVEN INDUSTRIES INC. - ALL RIGHTS RESERVED UNDER THE COPYRIGHT LAWS.			

8

7

6

5

4

3

2

1

8

7

6

5

4

3

2

1

REVISIONS					
LTR	ECO	DESCRIPTION	DATE	APPROVED	ZONE
A		INITIAL_RELEASE	1/18/2016	RWW	
B		REV_TITLE_BLOCK	3/28/2016	RWW	

NOTES:

XXXXX

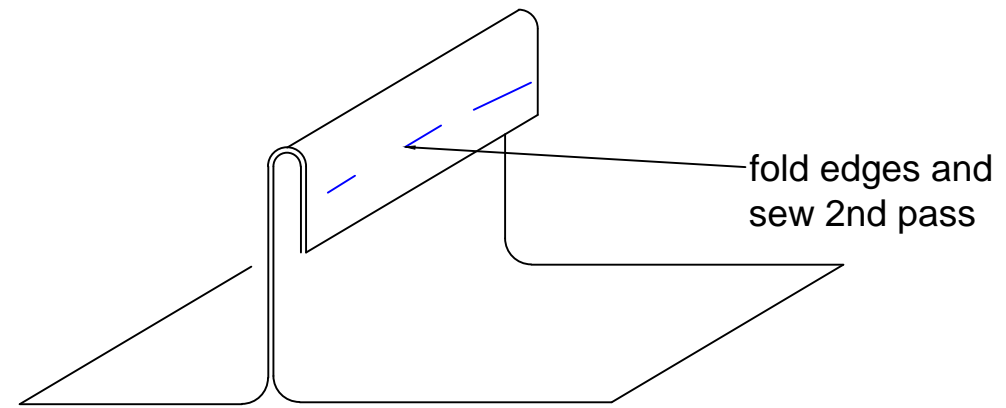
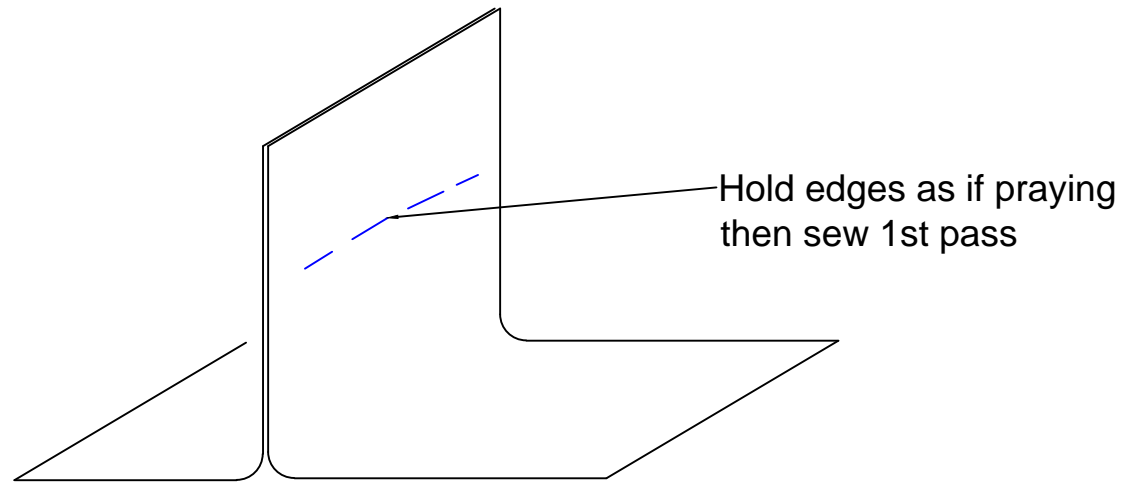

GENERAL SEWING INSTRUCTIONS

1. WHEN SEWING MAKE ABOUT A 15 FOOT PASS THEN PULL OUT AND RESTART SEWING ABOUT 3" BEHIND WHERE YOU PULLED OUT. THIS WILL LIMIT THE AMOUNT OF SEWING THAT CAN COME LOOSE FROM A POOR SEAM. DO THIS OVER THE ENTIRE LENGTH TO BE SEWN.
2. FOLD THE SEAM OVER AND REPEAT STEP 1 ACROSS THE ENTIRE LENGTH OF THE SEAM.

		COVER TYPE			
		GENERAL SEWING INSTRUCTIONS Page 3 of 3			
RAVEN ENGINEERED FILMS PO BOX 5107 SIOUX FALLS, SD 57117-5107 +1 (800) 635-3456		SIZE	SALES ORDER	DRAWING NUMBER	REV
DRAWN	RWW	DATE	1/18/2016	B	'
DO NOT SCALE DRAWING		PROPRIETARY AND CONFIDENTIAL INFORMATION OF RAVEN INDUSTRIES INC. THIS DRAWING AND THE INFORMATION HEREON ARE RAVEN INDUSTRIES INC. PROPERTY AND MAY BE USED BY OTHERS ONLY AS AUTHORIZED IN WRITING BY RAVEN INDUSTRIES INC. - ALL RIGHTS RESERVED UNDER THE COPYRIGHT LAWS.			

8

7

6

5

4

3

2

1